

GES-
-SO

COL-
LECT
-ION

ST:LLEBEN™

About	p. 03
Artisanal Production	p. 09
Gesso Collection	p. 17
Technical Sheet	p. 33

P.03

Gesso collection
Stilleben

A
bo
ut

P.04

Gesso collection
Stilleben



P.05

Gesso collection
Stilleben



Essential clean lines for contemporary design

Stilleben™ is an Italian brand, created in 2017, whose primary goal is to celebrate Italian craftsmanship. The brand name Stilleben™ is the German for “still life”. Specifically, the contemporary still life of the great masters like Giorgio Morandi, who portrays the world of common objects: vases, glasses, bottles, bowls. Everyday objects distinguished by pastel colours and attention to volumes. Through the search for essential clean lines and synthesis, Stilleben™ designs and creates its own products. With a careful look at the choice on the colour scale, the quality of the materials and a formal search for the essence of things.

P.06

Gesso collection
Stilleben



“Natura morta in German is called with another name, more beautiful and more right, the name is Stilleben, quiet life”

Giorgio De Chirico

P.08

Gesso collection
Stilleben



**Ceramic
Wood
Hemp**

P.09

Gesso collection
Stilleben

**Arti
sana
Pro
duc
tion**

P.10

Gesso collection
Stilleben

The Ceramic

For our tableware services, the quality of the material is crucial and that is why we have chosen vitrified stoneware, one of the most prized ceramics because it provides the best quality guarantees in terms of durability, lack of absorption of liquids, frost resistance easy to clean and being proof against any type of stain. It's not so simple to work. During firing, it shrinks in volume by 13%, vitrifies, and if the shapes have not been studied to perfection, they do not pass the "test" set by the kiln, which reaches 1200 °C.

Owing to its extraordinary hardness and resistance, vitrified stoneware makes a timeless tableware collection. The star of the collection is the surface, which has a solid and opaque exterior that absorbs light whereas inside it is glossy and reflects the light. Each customized production run passes through different phases that go from pouring into the mother mould to glazing, to firing in the muffle kiln and the final quality control. Each product, being handcrafted, is always slightly different from the next one in shape, finish and colour variations so that each one is an absolutely unique item. Therefore the irregularity of the shape is an intrinsic feature of the product.

P.11

Gesso collection
Stilleben



P.12

Gesso collection
Stilleben

The Wood

Italian walnut is an integral part of the collection. It is one of the finest woods for making furnishing complements, especially for the table. The close grain of the walnut wood means it can be easily and efficiently assembled to create stable, durable objects that are well finished and are not subject to warping over time. The greyish brown colour with light lines that vary from reddish to black and the straight veining that is always attractive to see are the physical properties that have most contributed to the success of walnut. Whilst walnut, like any other wood, can absorb or release humidity according to the climatic conditions of the environment, it is the wood that shrinks and swells least. Italian walnut is increasingly difficult to source and is considered to be a product of the highest quality.

P.13

Gesso collection
Stilleben

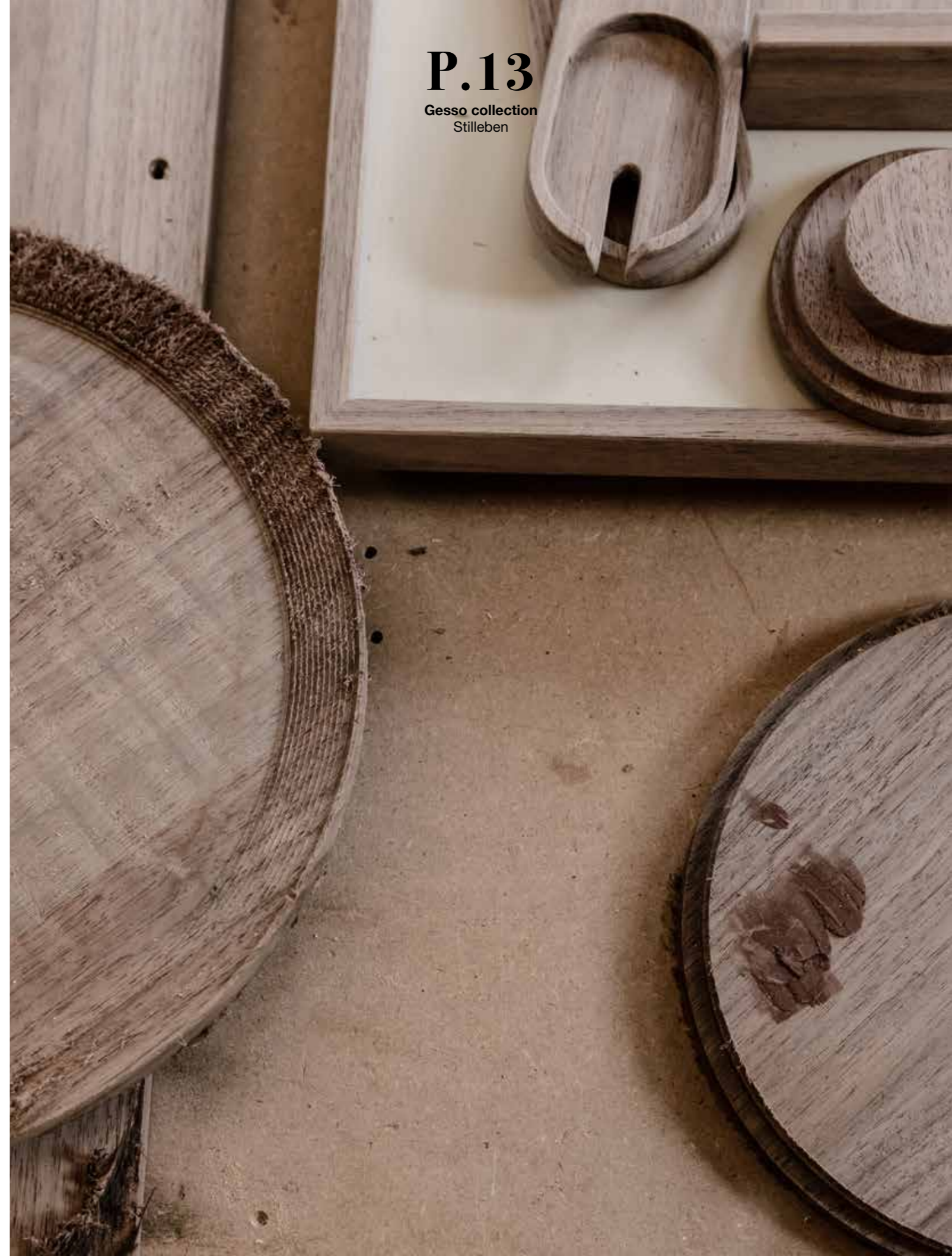

P.14

Gesso collection
Stilleben

The Hemp

Our fabric is made of pure hemp, a noble fibre that is hard to come by and is of much higher quality than more common products like linen and cotton. Of all the natural fibres, it is the one that is most resistant to wear and to tears, three times more so than cotton, thus making the products harder wearing. Natural hemp is also immune to mites, mould, fungus, bacteria and moths. It does not produce allergies or conduct electricity.

Moreover, hemp fibre is an everlasting, natural plant material that makes our life more intimate, responsible and respectful of the environment. During its growth cycle, hemp does not require pesticides, herbicides, chemical products or fertilizers. Its deep roots improve the quality of the land by feeding it with nitrogen. In addition, by absorbing the minerals, which are concentrated in the leaves, hemp crops do not damage the land on which it is cultivated.

P.15

Gesso collection
Stilleben

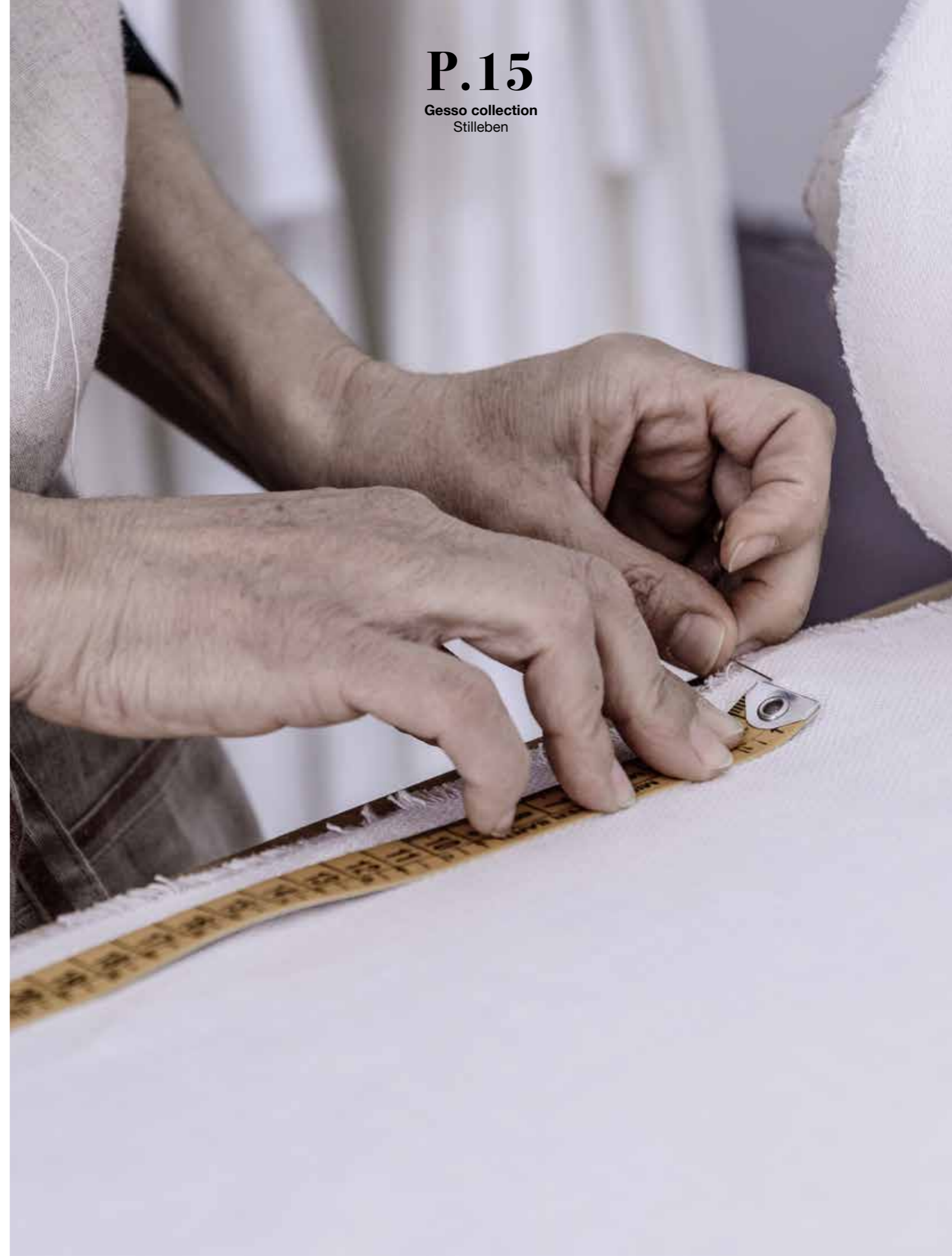

P.16

Gesso collection
Stilleben



P.17

Gesso collection
Stilleben

Ges
so
Collec
tion

P.18

Gesso collection
Stilleben

P.19

Gesso collection
Stilleben



Gesso is the first result of the search for essential clean lines and synthesis which Stilleben™ apply to the design and production of its product.

P.20

Gesso collection
Stilleben

P.21

Gesso collection
Stilleben

The collection is inspired by the tactile, material and opaque surfaces of the chalk, done by the porcelain which is handcrafted as all the materials used for the collection.



P.22

Gesso collection
Stilleben



P.23

Gesso collection
Stilleben



P.24

Gesso collection
Stilleben

P.25

Gesso collection
Stilleben



The materials are selected for their specific qualities and inherent potential after an exhaustive and passionate research: for our tableware services, the porcelain which, baking at 1200°C, is a very resistance material; for the textiles, the hemp, a noble fibre of considerable resource and hard to come by; for wooden complements, the national walnut, one of the finest woods thanks to the close grain.

P.26

Gesso collection
Stilleben



P.27

Gesso collection
Stilleben



P.28

Gesso collection
Stilleben



P.29

Gesso collection
Stilleben

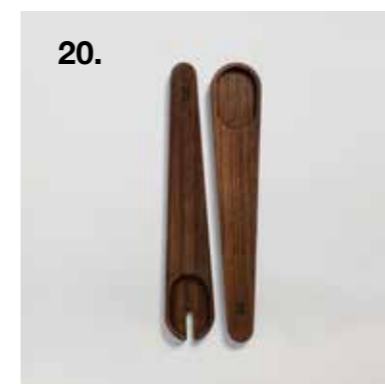

P.30

Gesso collection
Stilleben

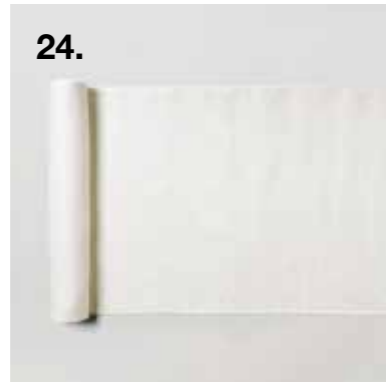

P.31

Gesso collection
Stilleben



P.32

Gesso collection
Stilleben



P.33

Gesso collection
Stilleben

Technical
Sheet

P. 34

Gesso collection
Stilleben

1.A 1.B

CONTAINER BIG

The container is ideal for keeping pasta, coffee, biscuits or other food owing to the lid with a hermetic silicone seal that keeps out humidity and keeps products fresh.

Dimensions ceramic/ Ø20,5cm x H10,2cm

Dimensions lid / Ø20,5cm x H1cm

Materials/ Gres Porcelain, Italian Walnut

Colours/ White gloss interior and white matt exterior, Light green gloss interior and light green matt exterior

Options/ Available with lid or without lid

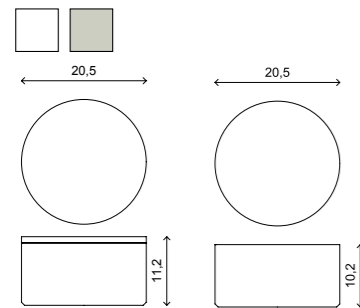

2.A 2.B

CONTAINER SMALL

The container is ideal for keeping pasta, coffee, biscuits or other food owing to the lid with a hermetic silicone seal that keeps out humidity and keeps products fresh.

Dimensions ceramic/ Ø16,5cm x H7cm

Dimensions lid / Ø16,5cm x H1cm

Materials/ Gres Porcelain, Italian Walnut

Colours/ White gloss interior and white matt exterior, Light green gloss interior and light green matt exterior

Options/ Available with lid or without lid

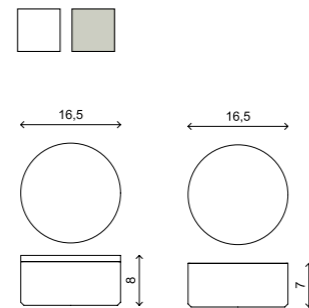

3.

STARTERS TRAY WITH WOODEN CHOPPING BOARD

The starters tray is a ceramic plate with compartments for separating sauces and foods. The edges of the tray thus enable the different tastes to be kept separate. In one of the compartments there is a small chopping board made of Italian walnut for cutting food.

Dimensions starters tray/ Ø30,5cm x T1,5cm

Dimensions chopping board/ Ø14,5cm x T1,5cm

Materials/ Gres Porcelain, Italian Walnut

Colours/ White gloss interior and white matt exterior, Light green gloss interior and light green matt exterior

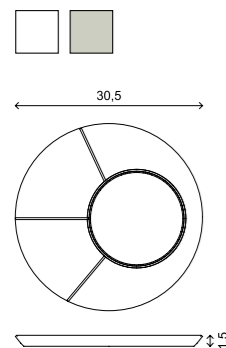

4.

STARTERS TRAY WITH WOODEN TRAY

The starter tray is ideal for serving starters and side dishes. The structure with its removable cups ensures maximum filling and cleaning convenience.

Dimensions wooden tray/ Ø22,8cm x T2cm

Dimensions ceramic bowls/ Ø8cm x H5cm

Materials/ Gres Porcelain, Italian Walnut

Colours/ White gloss interior and white matt exterior, Light green gloss interior and light green matt exterior

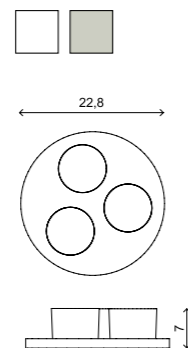

P. 35

Gesso collection
Stilleben

5.

PLATE

Simplicity and delicacy distinguish the dining set. The toughness of the ceramics enables them to be used every day also because of the resistant properties of the vitrified stoneware.

Dimensions of plate/ Ø 25,5cm x T1,5cm

Materials/ Gres Porcelain

Colours/ White gloss interior and white matt exterior, Light green gloss interior and light green matt exterior.

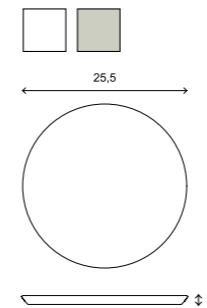

6.

DESSERT BOWL

Simplicity and delicacy distinguish the dining set. The toughness of the ceramics enables them to be used every day, also because of the resistant properties of the vitrified stoneware.

Dimensions of plate/ Ø22cm x T1,5cm

Materials/ Gres Porcelain

Colours/ White gloss interior with white matt exterior, Light green gloss interior with light green matt exterior.

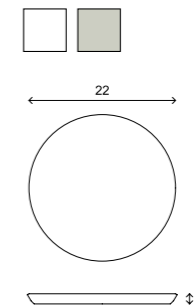

7.

SHALLOW BOWL FOR PASTA

Simplicity and delicacy distinguish the dining set. The toughness of the ceramics enables them to be used every day, also because of the resistant properties of the vitrified stoneware.

Dimensions of plate/ Ø20,5cm x H3,5cm

Materials/ Gres Porcelain

Colours/ White gloss interior with white matt exterior, Light green gloss interior with light green matt exterior.

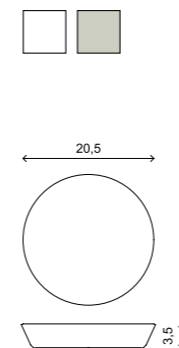

8.

SOUP BOWL

Simplicity and delicacy distinguish the dining set. The toughness of the ceramics enables them to be used every day, also because of the resistant properties of the vitrified stoneware.

Dimensions of plate/ Ø17cm x H6cm

Materials/ Gres Porcelain

Colours/ White gloss interior with white matt exterior, Light green gloss interior with light green matt exterior.

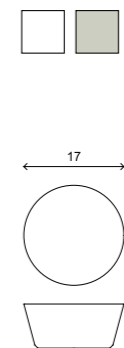

P. 36

Gesso collection
Stilleben

9.

BEAKER

The thin edge and glossy glaze make it perfect for drinking water, tea and coffee and the slanted sides make it easy to stack.

Dimensions/ Ø8cm x H7,5cm

Materials/ Gres Porcelain

Colours/ White gloss interior and white matt exterior, Light green gloss interior and light green matt exterior

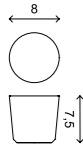

10.

SALAD BOWL

This salad bowl, with its clean and elegant lines, presents salad, fruit, pasta or any other culinary creation with a touch of elegance and design.

Dimensions/ Ø23,5cm x H9cm

Materials/ Gres Porcelain

Colours/ White gloss interior and white matt exterior, Light green gloss interior and light green matt exterior

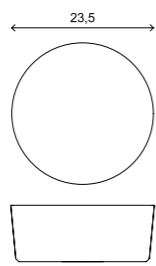

11.

BOWL

The bowl is perfect for serving side dishes and nibbles to accompany the main dishes.

Dimensions / Ø15,5cm x H7cm

Materials/ Gres Porcelain

Colours/ White gloss interior and white matt exterior, Light green gloss interior and light green matt exterior

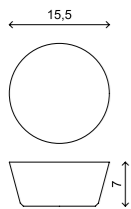

12.

CARAFE (OR VASE)

The carafe is suitable to fill it with hot or cold drink and pour the contents into the coordinated glasses for an elegant way of serving. Or to be transformed it into a handsome vase for flowers.

Dimensions/ Ø10cm x H25cm

Materials/ Gres Porcelain

Colours/ White gloss interior and white matt exterior, Light green gloss interior and light green matt exterior

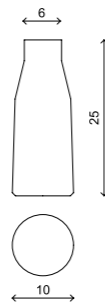

P. 37

Gesso collection
Stilleben

13.

WOODEN UNDERPLATE

An Italian walnut underplate to enhance the table with an element that distinguishes the fine mise en place.

Dimensions/ Ø28,8cm x T1cm

Materials/ Italian Walnut

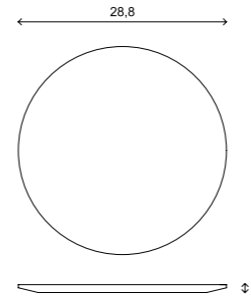

14.

MUG

The ceramic mug is characterized by a matt outer surface that enhances the purity of the colour and feel. The large handle enables the mug to be gripped easily and the heat to be insulated correctly.

Dimensions/ L12cm x H9,7cm x D7,7cm

Materials/ Gres Porcelain

Colours/ White gloss interior with white matt exterior, Light green gloss interior with light green matt exterior

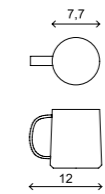

15.

SUGAR BOWL

The sugar bowl is characterized by a matt outer surface that enhances the purity of colour and feel and by a gloss interior. The ceramic element is combined with a lid of Italian walnut.

Dimensions ceramic/ Ø7,8cm x H5,8cm

Dimensions lid/ Ø7,8cm x T1cm

Materials/ Gres Porcelain, Italian Walnut

Colours/ White gloss interior and white matt exterior, Light green gloss interior and light green matt exterior

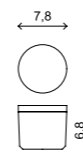

16.

COFFEE CUP

The thin edge and the delicate form make the cup ideal for sipping an espresso or sake.

Dimensions/ Ø6cm x H5,2cm

Materials/ Gres Porcelain

Colours/ White gloss interior and white matt exterior, Light green gloss interior and light green matt exterior

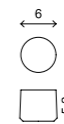

P. 38

Gesso collection
Stilleben

17.

TEAPOT

The teapot is a unique daily design object. The rigour of the essential and geometric form is set off by the warmth of the wood that clads the steel handle and the lid. The lid has a silicone seal that is approved for foodstuffs that prevents heat loss and enables the tea to be poured without it escaping from the top opening.

Dimensions/ L22cm x H20,3cm x D17,5cm

Materials/ Gres Porcelain, Italian Walnut

Colours/ White gloss interior and white matt exterior, Light green gloss interior and light green matt exterior

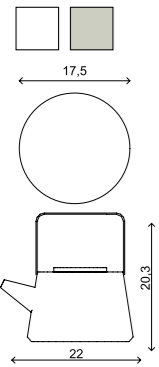

18.

MINI TRAY

A new and refined alternative to the large and more cumbersome tray for serving just two cups of coffee or tea.

Dimensions/ L9,5cm x H3cm x W27cm

Materials/ Italian walnut

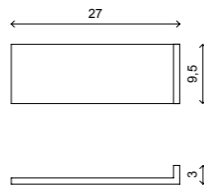

19.

TRAY

The tray can be used for serving anything from a cup of hot coffee to a dinner cooked at home, or to hold your objects. It has a scratchproof laminated bottom and an Italian walnut frame. The structure with feet also enables the tray to be raised easily.

Dimensions/ L39,5cm x H4cm x W22,5cm

Materials/ Italian Walnut

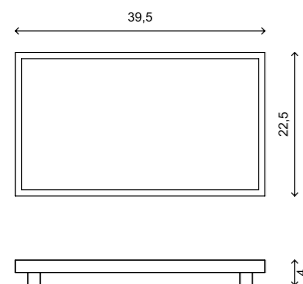

20.

SET OF TWO WOODEN LADLES

A wooden spoon and fork are some of the most essential items in any kitchen. Characterized by long handles that widen at the part of the tool, this version is one modern and elegant interpretation.

Dimensions/ L30,5cm x H1cm x W5,5cm

Materials/ Italian Walnut

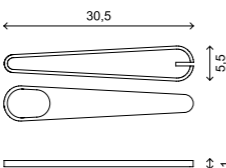

P. 39

Gesso collection
Stilleben

21.

CHOPPING BOARD

The chopping board is characterized by the simple geometry, sculpted shape and functionality. It makes a perfect work surface for slicing sausage, cheese and fruit. In addition to being an elegant addition to the kitchen, it can express all its beauty as a serving tray that can be the centrepiece on the table.

Dimensions/ L45,5cm x H4cm x W28cm

Materials/ Italian Walnut

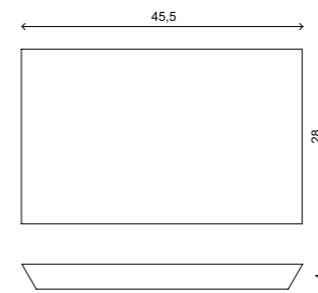

22.

PLACEMAT

An elegant, modern, essential placemat that is at the same time versatile: for breakfast, for snacks or for placing on the tablecloth.

Dimensions/ L46,5cm x W37cm

Materials/ Pure Hemp

Colours/ Striped white

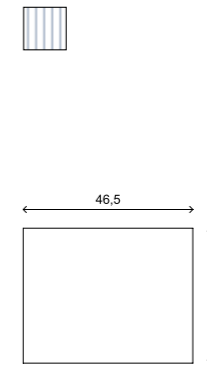

23.

TABLECLOTH 180/230

The hemp tablecloth is distinguished by absolutely essential lines for a sober and refined taste. The white colour is a neutral and elegant base for the table's mise en place.

Dimensions/ L180/230cm x W140cm

Materials/ Pure Hemp

Colours/ White

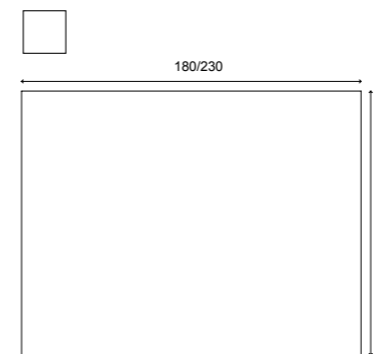

24.

RUNNER

The runner can replace the tablecloth or further enhance it if it is positioned above it. It adds an informal and carefree look to the laid table.

Dimensions/ L146,5cm x W46,5cm

Materials/ Pure Hemp

Colours/ White, Striped white

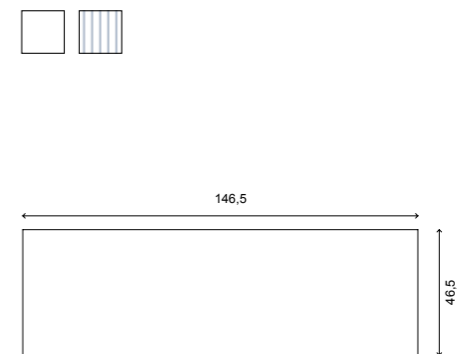

P. 40

Gesso collection
Stilleben

25.

NAPKIN

Hemp napkin that can be combined with coordinated white tablecloth.

Dimensions/ L46,5cm x W46,5cm

Materials/ Pure Hemp

Colours/ White, Striped white

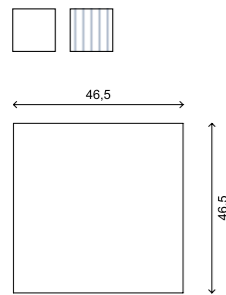

26.

TEASPOON

Spoon made entirely by hand by our master craftsmen and differences in form or colour are what make the product unique.

Dimensions/ L10cm

Materials/ Gres Porcelain

Colours/ White gloss spoon and white matt handle, Light green gloss spoon and light green matt handle



29.

FLOWER VASES FOR WALL WITH SIDE HOLE

A small, elegant and amusing flower vase with a classical parallelepipedon shape that can be mounted on the wall.

Dimensions size L/ L7,2cm x H7,2cm x W7,2cm

Dimensions size S/ L7,2cm x H3,5cm x W7,2cm

Materials/ Gres Porcelain

Colours/ White gloss exterior, Light green gloss exterior

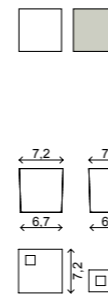

30.

FLOWER VASES FOR WALL WITH FRONT HOLE

A small, elegant and amusing flower vase with a classical parallelepipedon shape that can be mounted on the wall.

Dimensions size L/ L7,2cm x H7,2cm x W7,2cm

Dimensions size S/ L7,2cm x H3,5cm x W7,2cm

Materials/ Gres Porcelain

Colours/ White gloss exterior, Light green gloss exterior

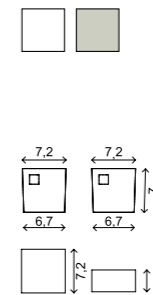

27.

SALT AND PEPPER SET

The set consists of a ceramic salt cellar and pepper pot and a wooden tray. The ceramic elements are characterized by a matt outer surface that enhances the purity of colour and feel, and by a gloss interior. The Italian walnut tray is crafted to hold the salt cellar and pepper pot firmly in place.

Dimensions tray/ L12,6cm x W6,7cm x T1,2cm

Dimensions salt and pepper container/ Ø4,8cm x H7,7cm

Materials/ Gres Porcelain, Italian Walnut

Colours/ White matt exterior, light green matt exterior

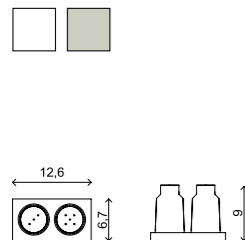

28.

FLOWER VASES FOR TABLE

The vase is small, elegant and fun with a classical parallelogram shape and can be positioned not just on the table but also on a living room shelf, on the kitchen counter.

Dimensions size L/ L7,2cm x H7,2cm x W7,2cm

Dimensions size S/ L7,2cm x H3,5cm x W7,2cm

Materials/ Gres Porcelain

Colours/ White gloss exterior, Light green gloss exterior

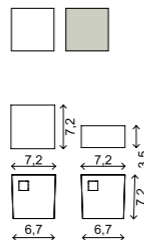

31.

SMALL BOWL

Characterized by a contemporary look that permits perfect interaction between function and visual appeal, the ceramic bowl is the ideal complement for enhancing the mise en place of the table.

Dimensions/ Ø10,5cm x H6cm

Materials/ Gres Porcelain

Colours/ White gloss interior and white matt exterior, Light green gloss interior and light green matt exterior

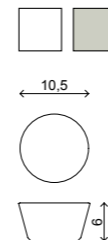

32.

TEA INFUSER

The filter is very handy for having a good quick cup of tea made from loose tea leaves or a cup of herbal tea.

Dimensions/ Ø8,2cm x H6,5cm

Materials/ Gres Porcelain

Colours/ White gloss, Light green gloss

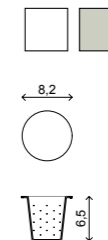

P. 42

Gesso collection
Stilleben

33.

SERVING PLATE ON BASE

The geometric and simple design of the serving plate on base consists of two elements that suggest a double use: the plate for showing off the cakes and savoury nibbles and the wooden base that becomes a handy container once the upper plate has been removed.

Dimensions ceramic plate/ Ø31cm x T2cm

Dimensions wooden base/ Ø19cm x H4,4cm

Materials/ Gres Porcelain, Italian Walnut

Colours/ White gloss interior and white matt exterior, Light green gloss interior and light green matt exterior

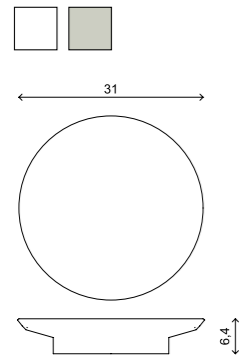

34.

SERVING PLATE

The elegant and refined serving plate is ideal for enhancing any dish that needs to be carefully presented. An accessory that is also suitable for informal lunches and suppers that looks well in the centre of the table, where it lends the table a note of stylish distinction.

Dimensions/ Ø31cm x T2cm

Materials/ Gres Porcelain

Colours/ White gloss interior and white matt exterior, Light green gloss interior and light green matt exterior

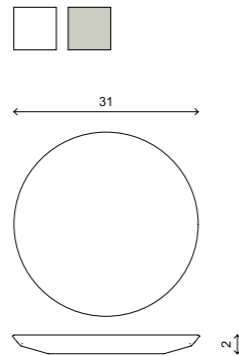

35.

CANDLE HOLDER

The candle holder is characterized by its cylindrical shape and is made of ceramics and Italian walnut. The essential form is functional to its use because it is suitable for both normal wax candles and stick candles. It is simple and elegant and it completes the collection by spreading a soft and intimate light over the table.

Dimensions / Ø5,2cm x H5,7,7cm

Materials/ Gres Porcelain, Italian Walnut

Colours/ White matt, Light green matt

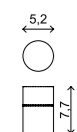

36.

TEACUP

The delicate and defined shapes and the thin edge make the cup ideal for sipping a good tea. The matching saucer is also available that is designed to hold the cup in position during transport.

Dimensions/ Ø9,5cm x H7cm

Materials/ Gres Porcelain

Colours/ White gloss interior and white matt exterior, Light green gloss interior and light green matt exterior

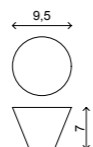

P. 43

Gesso collection
Stilleben

37.

TALL GLASS

The tilted sides enable it to be stacked and the thin and glazed glossy edge make it perfect for serving freshly squeezed fruit juice, fruit juice and cocktails in style or for just presenting breadsticks on the table. The matching saucer is also available.

Dimensions/ Ø7cm x H13cm

Materials/ Gres Porcelain

Colours/ White gloss interior and white matt exterior, Light green gloss interior and light green matt exterior

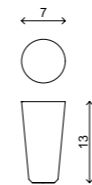

38.

SIDE PLATE

A side plate made of Italian walnut to enhance the set table with an element that makes a distinguished mise en place.

Dimensions/ Ø15,5cm

Materials/ Italian Walnut

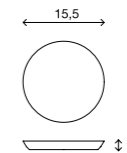

39.

SAUCER

Saucer with recess for both teacups and tall glasses to enable them to be carried around.

Dimensions/ Ø11,5cm

Materials/ Gres Porcelain

Colours/ White gloss interior and white matt exterior, Light green gloss interior and light green matt exterior

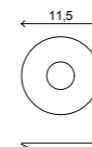

40.

PLATE

Simplicity and delicacy distinguish the dining set. The toughness of the ceramics enables them to be used every day also because of the resistant properties of the vitrified stoneware.

Dimensions of plate/ Ø 25,5cm x T1,5cm

Materials/ Gres Porcelain

Colours/ White gloss with green dots interior and white matt exterior, Light green gloss interior with green dots and light green matt exterior

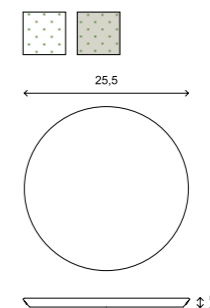

P. 44

Gesso collection
Stilleben

41.

DESSERT BOWL

Simplicity and delicacy distinguish the dining set. The toughness of the ceramics enables them to be used every day, also because of the resistant properties of the vitrified stoneware.

Dimensions of plate/ Ø22cm x T1,5cm

Materials/ Gres Porcelain

Colours/ White gloss with green dots interior and white matt exterior, Light green gloss interior with green dots and light green matt exterior

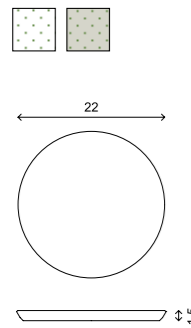

42.

SHALLOW BOWL FOR PASTA

Simplicity and delicacy distinguish the dining set. The toughness of the ceramics enables them to be used every day, also because of the resistant properties of the vitrified stoneware.

Dimensions of plate/ Ø20,5cm x H3,5cm

Materials/ Gres Porcelain

Colours/ White gloss with green dots interior and white matt exterior, Light green gloss interior with green dots and light green matt exterior

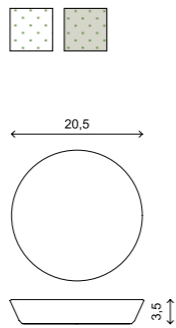

43.

SOUP BOWL

Simplicity and delicacy distinguish the dining set. The toughness of the ceramics enables them to be used every day, also because of the resistant properties of the vitrified stoneware.

Dimensions of plate/ Ø17cm x H6cm

Materials/ Gres Porcelain

Colours/ White gloss with green dots interior and white matt exterior, Light green gloss interior with green dots and light green matt exterior

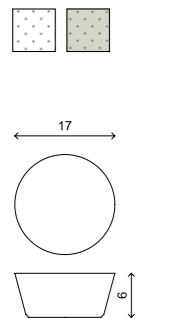

44.A 44.B

TUREEN

The design and the lines of the tureen, a classic of the tableware collections, have been given a modern makeover in line with the entire collection. The handles have been shaped at the bottom to enable them to be picked up easily whilst the lid has a hole for the ladle.

Dimensions tureen without lid/ Ø 27,5cm x H14cm

Dimensions lid/ Ø 21,5cm x H5cm

Materials/ Gres Porcelain

Colours/ White gloss interior with white matt exterior, Light green gloss interior with light green matt exterior

Options/ Available with lid or without lid

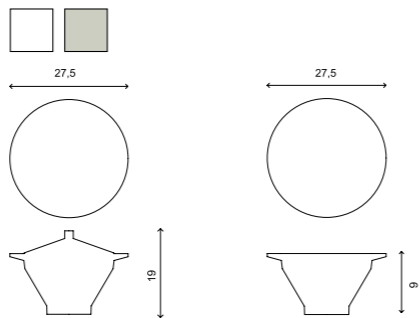

45.

OVERHEAD LAMP

The design of this lamp is simple and pure and this makes it suitable for both public and private settings. Inside, the stylized silhouette reflects the light that falls as a cone. The entire lamp is made of suitable materials that withstand sources of heat. The coordinated ceiling rose is made of vitrified stoneware of the same material and finish as the lamp. A kit for the installation is also included. The cable lead can be customized by choosing from 5 different colours. A 100 W (equivalent of 1800 lm) halogen lamp is recommended because of its brilliance

Technical information/

Hanging lamp and ceiling rose made of handcrafted vitrified stoneware that withstands high temperatures (1200 °C). Stainproof, as hard as glass, non-absorbent, maintains colour and shape over time. Inner lamp support and bracket included in the galvanized metal ceiling rose.

White ceramic lamp hold that withstands high temperatures. 2x0.75 cable, 3 metres in length / Light directed downwards / Provided with E27 fitting.

Dimensions/ Ø18cm x H28cm

Materials/ Gres Porcelain

Colours lamp/ White matt, light green matt



Colours cable/ White, beige, black, multicolor, hemp

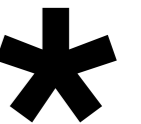
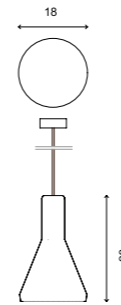

Instructions on use/

CERAMIC

Suitable for microwave, electric or gas ovens. Withstands temperatures up to at least 200°C. Do not place in direct contact with hot parts and wash the product only once it has cooled to avoid any thermal shock. Can be washed in the dishwasher.

WOOD

Clean with a wet cloth or a sponge. Do not leave to soak and/or put into the dishwasher.

HEMP

Wash max 30° and iron wet. No bleaching.

CREDITS

Graphic design: Team99
Text: Stilleben™
Photo credits: Studio Gi
Set design: Stilleben™

Printed and bound in Italy. July 2019

**All rights are reserved. Not any part of this
work can be reproduced in any way without the
preventive written authorization by Stilleben™.
All work is copyrighted © to their respective owners.**

Showroom and Offices
Via San Pietro, 4
41121 Modena - Italy
T +39 059 8300882
F +39 059 2154763

info@stilleben.it
www.stilleben.it
© Stilleben 2019



ST:LLEBEN™